



DATOS MOTOR

POTENCIA	4HP
REVOLUCIONES	1760
FRECUENCIA	60HZ
TORQUE MOTOR NOMINAL	16,6
CARCASA (PAM)	112(B5)
TIPO BRIDA	FF-215
EFICIENCIA MOTOR	IE 2

DATOS REDUCTOR

REFERENCIA	550023
TIPO	ORTOGONAL
MODELO	FCNDK
MATERIAL	HIERRO
CARCASA	110
RELACION DE TRANSMISION i:	30
VELOCIDAD SALIDA	58,67
TORQUE MAXIMO	680
TORQUE OPERACIÓN	393
FACTOR DE SERVICIO	1,7

PLANOS REDUCTOR

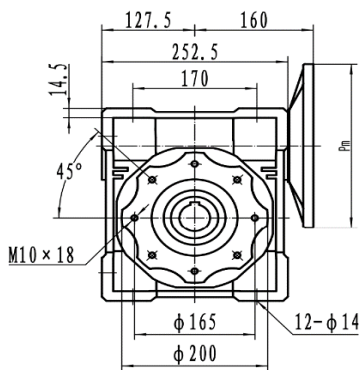

FCN 110

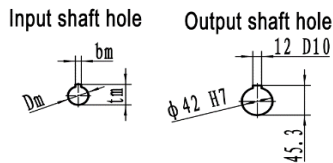

	Pm	Dm	bm	tm
80B5	200	19	6	21.8
90B5	200	24	8	27.3
90B14	140			
100/112B5	250	28	8	31.3
100/112B14	160			
132B5	300	38	10	41.3
132B14	200			

